

ネットプリント part11

セリア『がま口金』でつくる

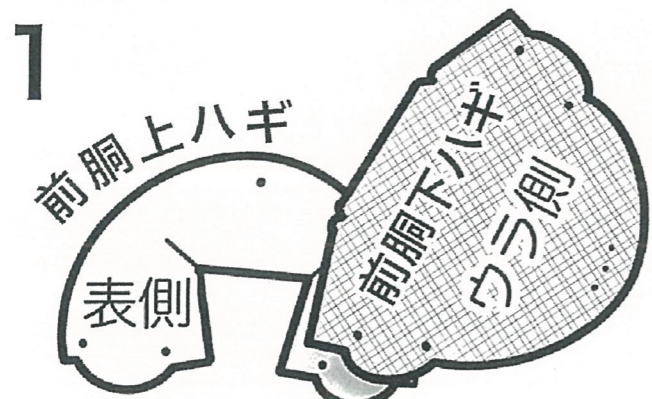

前胴の上ハギ 下ハギの
端を合わせて

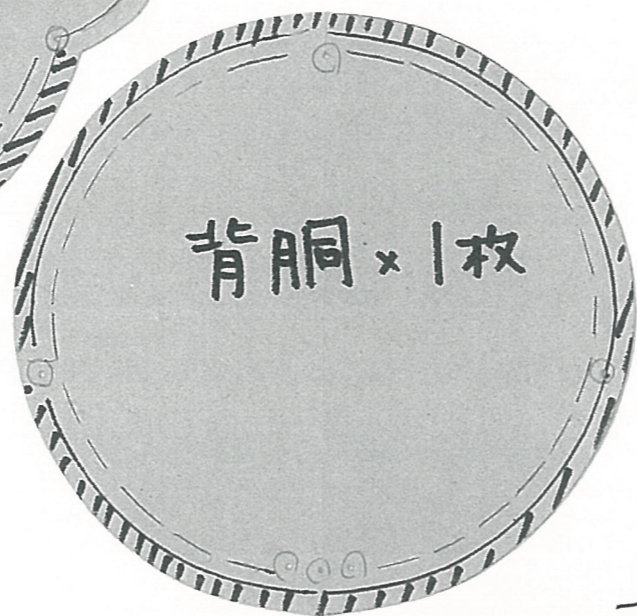
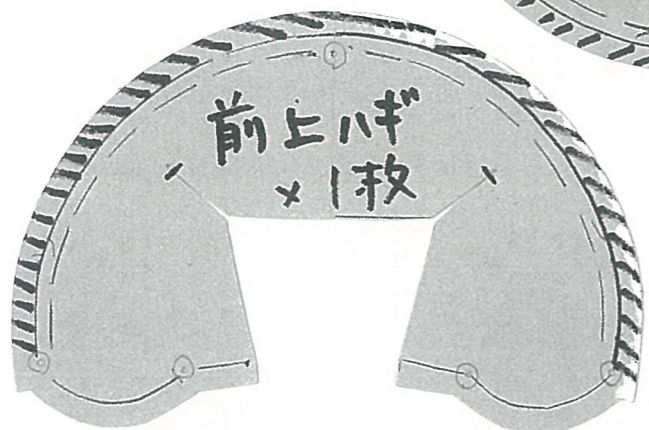
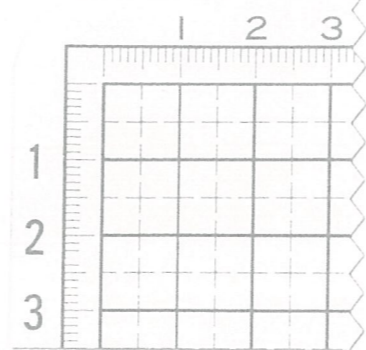
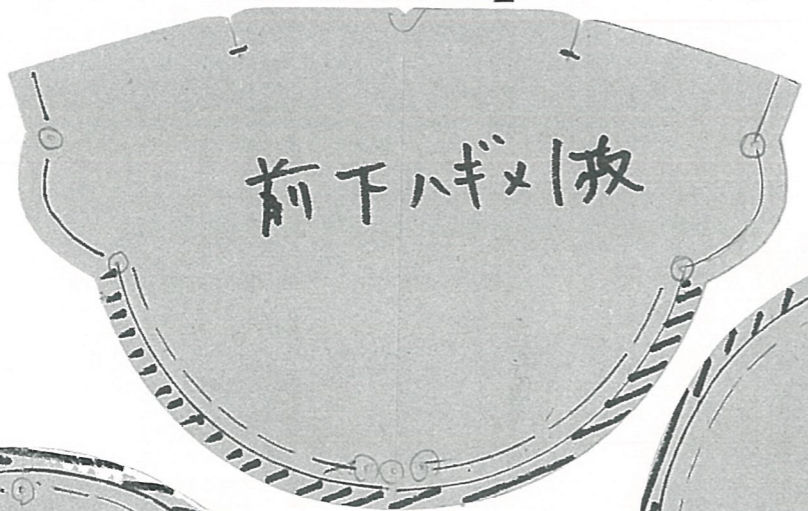
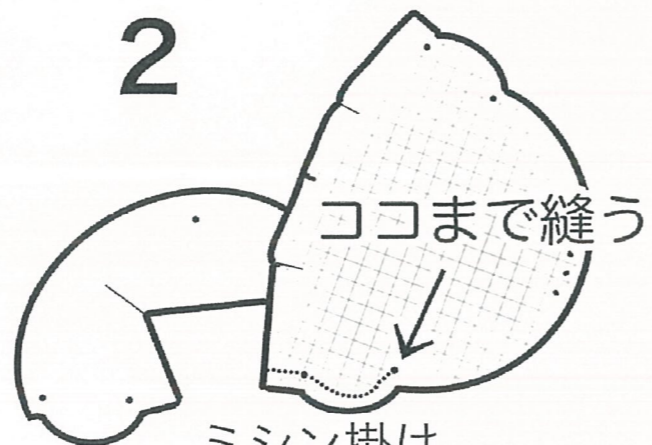

ミシン掛け
(縫い代3mm)



裏返しして

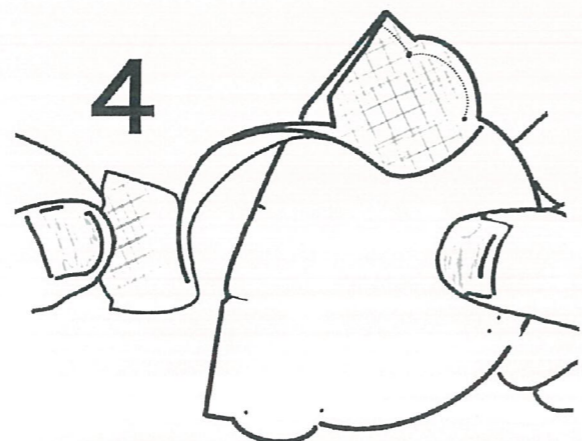

反対側の端も合わせる

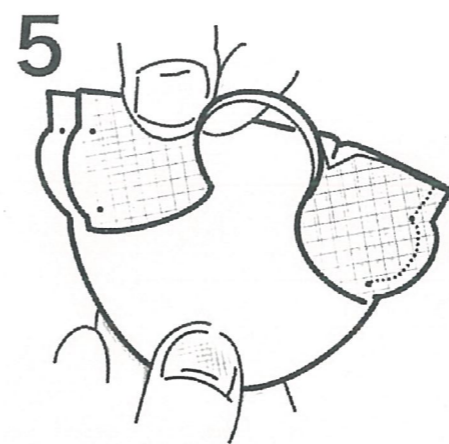

反対側の端も合わせて
*ねじれに注意

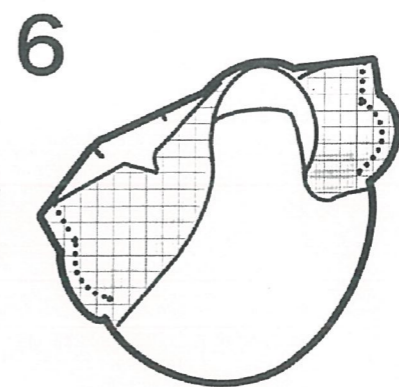

ミシン掛け
(縫い代3mm)
*縫い止め位置に注意

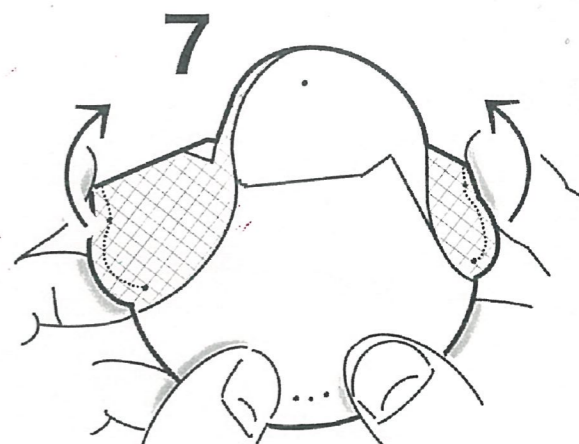

左右の端を
矢印の方向へ折る

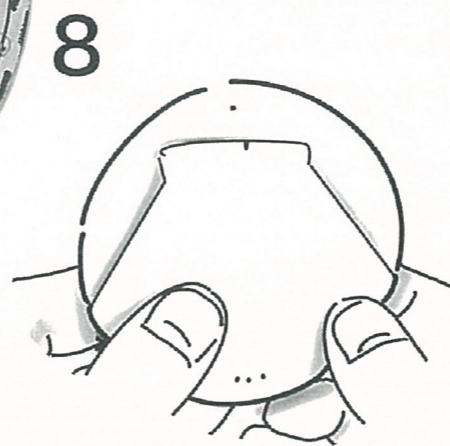

前胴が完成

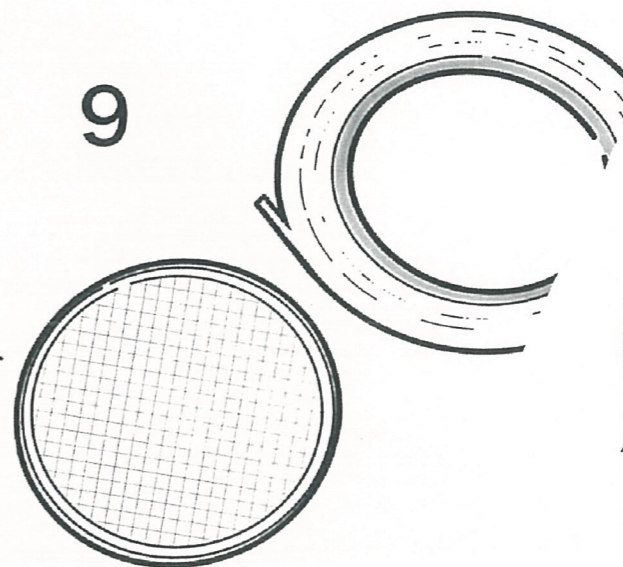

背胴のウラ側のフチ
一周 両面テープを貼る

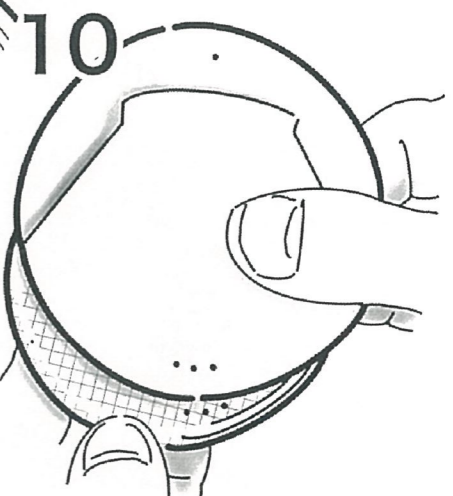

両面テープをはがして
下部の3連目打ち穴から
貼り合わせる

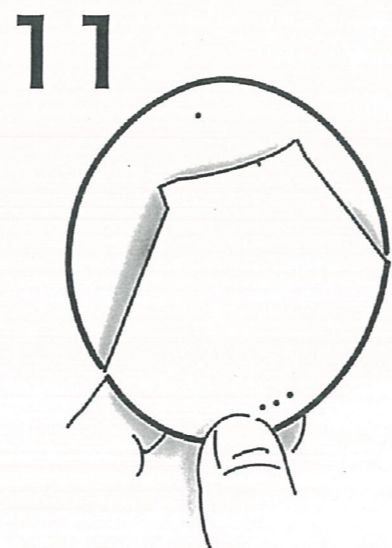

フチを一周貼り合わせる

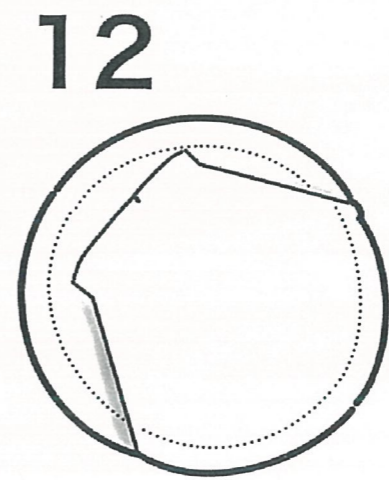

一周ミシン掛けする
(縫い代5mm)

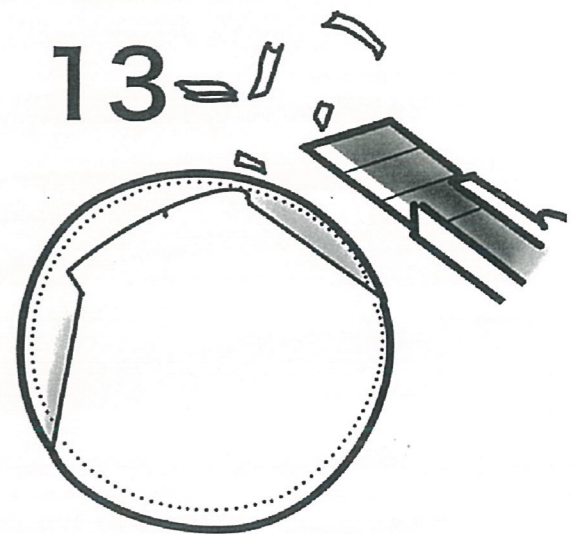

フチから外側3mmを
切り落として完成